

Holder for protective hose Plastic Polyamide 21.2 mm 5030025216

Allgemeine Informationen

Products_Model	ET0538612
EAN	4025113199867
Producer	Flexa
Producer-Model	15030025216
Producer-Typ	RQH AD21,2sw
min. Order	
Class	Halter für Schutzschläuche

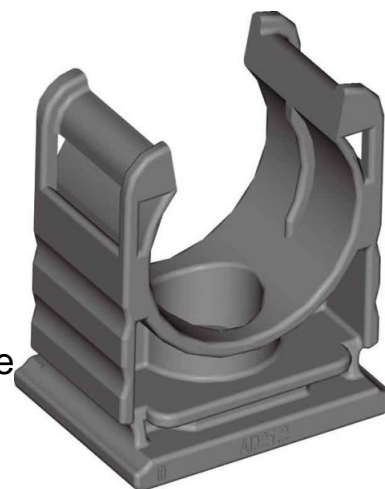

Technische Informationen

Werkstoff	
Werkstoffgüte	
Nenndurchmesser	21.2mm
Farbe	
Befestigungsart	

[Holder for protective hose Plastic Polyamide 21.2 mm 5030025216 online kaufen](#)

