

## Cable protection for installation duct Other LER 60.060

### Allgemeine Informationen

Products_Model	ET0412582
EAN	4013339865208
Producer	Niedax
Producer-Model	LER 60.060
Producer-Typ	LER 60.060
min. Order	
Class	Kabelschutz für Installationskanal

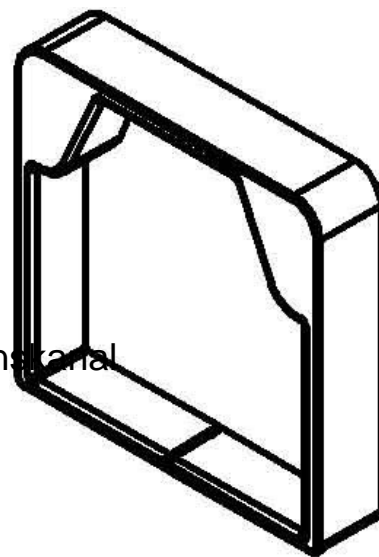

### Technische Informationen

Geeignet für	
Werkstoffgüte	
Bauform	
Länge	60mm
Breite	60mm
Farbe	

[Cable protection for installation duct Other LER 60.060 online kaufen](#)

