

Bracket for cable support system 260 mm 75 mm KTT 250

Allgemeine Informationen

Products_Model	ET0412169
EAN	4013339181902
Producer	Niadax
Producer-Model	KTT 250
Producer-Typ	KTT 250
min. Order	
Class	Ausleger für Kabeltragsystem

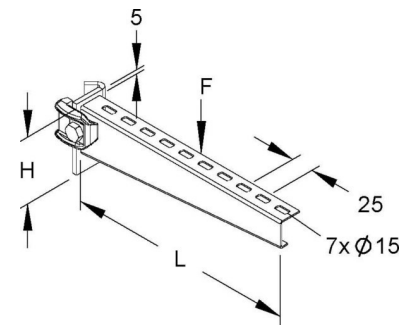

Technische Informationen

Länge	260mm
Höhe	75mm
Ausführung	
Winkel	90...90°
Tragfähigkeit	2.5kN
Werkstoff	
Rostfreier Stahl, gebeizt	
Werkstoffgüte	
Oberfläche	
Farbe	

[Bracket for cable support system 260 mm 75 mm KTT 250 online kaufen](#)

