

Electrical accessories for luminaires 22169788

Allgemeine Informationen

Products_Model	ET5306638
EAN	9008709807860
Producer	Zumtobel Licht
Producer-Model	22169788
Producer-Typ	SUP2 TRACK #22169788
min. Order	
Class	Elektrisches Zubehör für Leuchten

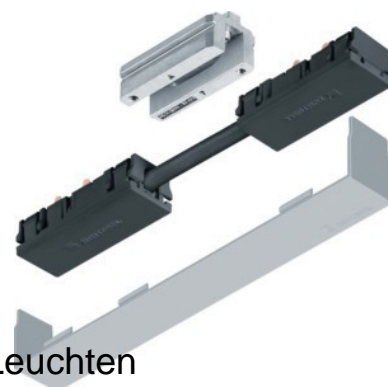

Technische Informationen

Farbe

[Electrical accessories for luminaires 22169788 online kaufen](#)

