

## Enlargement/reducing ring Metric 16 1897P09M16

### Allgemeine Informationen

Products_Model	ET0485005
EAN	4011126377545
Producer	Kleinhuis
Producer-Model	1897P09M16
Producer-Typ	1897P09M16
min. Order	
Class	Erweiterungs-/Reduzierring

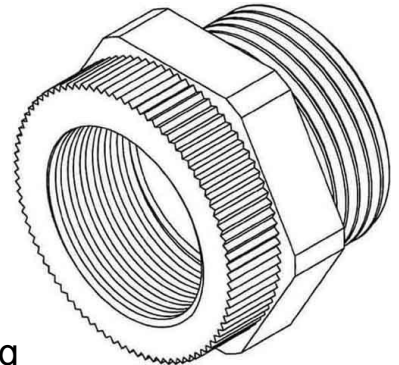

### Technische Informationen

Gewindeart Innengewinde
Gewindemaß metrisch Innengewinde
Gewindeart Außengewinde
Gewindemaß PG Außengewinde
Werkstoff
Vernickelt
Explosionssgeschützt

[Enlargement/reducing ring Metric 16 1897P09M16 online kaufen](#)

