

## T-head bolt for channels Steel Other HM 408/20

### Allgemeine Informationen

Products_Model	ET0411744
EAN	4013339122806
Producer	Niedax
Producer-Model	HM 408/20
Producer-Typ	HM 408/20
min. Order	
Class	Hammerkopfschraube

### Technische Informationen

Werkstoff	
Werkstoffgüte	
Oberfläche	
Gewindemaß metrisch	
Länge	20mm
Kopfbreite	31mm
Geeignet für Montageschiene	

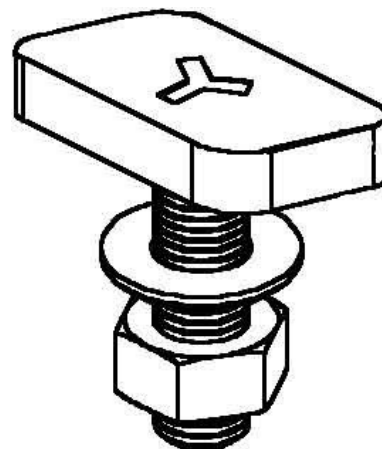

[T-head bolt for channels Steel Other HM 408/20 online kaufen](#)

