

## T-head bolt for channels Steel HK 512/30

### Allgemeine Informationen

Products_Model	ET0411743
EAN	4013339124206
Producer	Niedax
Producer-Model	HK 512/30
Producer-Typ	HK 512/30
min. Order	
Class	Hammerkopfschraube

### Technische Informationen

Werkstoff	
Oberfläche	
Gewindemaß metrisch	
Länge	30mm
Kopfbreite	32.5mm
Geeignet für Montageschiene	

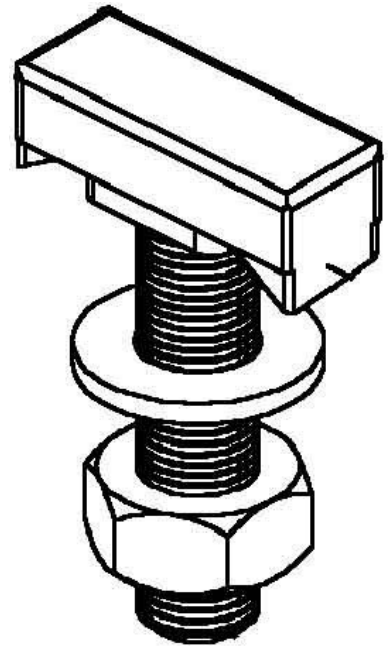

[T-head bolt for channels Steel HK 512/30 online kaufen](#)

