

Flat bend for installation duct 40 mm 40 mm LUWC 40.040 R

Allgemeine Informationen

Products_Model	ET5206153
EAN	4013339833221
Producer	Niedax
Producer-Model	LUWC 40.040 R
Producer-Typ	LUWC 40.040 R
min. Order	
Class	Flachwinkel für Leitungsführungskanal

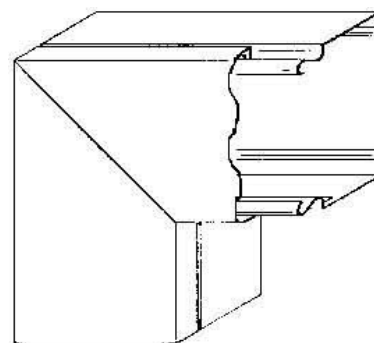

Technische Informationen

Höhe	40mm
Breite	40mm
Ausführung	
Winkel	90...90°
Werkstoff	
Werkstoffgüte	
Halogenfrei	
Geeignet für Funktionserhalt	
Oberfläche	
Farbe	
RAL-Nummer	
Schutzfolie	
Befestigungsart	

[Flat bend for installation duct 40 mm 40 mm LUWC 40.040 R online kaufen](#)

