

Mounting plate for cable protection tubes Metal MIMPA 30/175E3

Allgemeine Informationen

Products_Model	ET5404307
EAN	4013339908264
Producer	Niadax
Producer-Model	MIMPA 30/175 E3
Producer-Typ	MIMPA 30/175 E3
min. Order	
Class	Montageplatte für Installationsrohre/Kabelschutzrohre

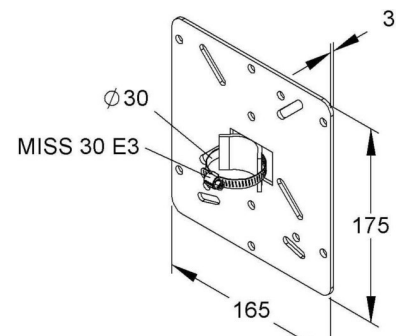

Technische Informationen

Werkstoff	
Oberfläche	
Oberfläche poliert	
Außendurchmesser	30mm
Breite	165mm
Höhe	175mm

[Mounting plate for cable protection tubes Metal MIMPA 30/175E3 online kaufen](#)