

## Fixing clamp Clamp Thread 10 AH38-AM10T

### Allgemeine Informationen

Products_Model	ET0477188
EAN	4013339745807
Producer	Niadax
Producer-Model	AH38-AM10T
Producer-Typ	AH38-AM10T
min. Order	
Class	Befestigungsklammer

### Technische Informationen

Befestigungsart	
Anschlussart/-bauteil	
Gewindemaß metrisch	
Geeignet für Flanschstärke	3...8mm
Scharnierend	
Scharnier justierbar	
Werkstoff	
Oberfläche	
Bruchlast	680N

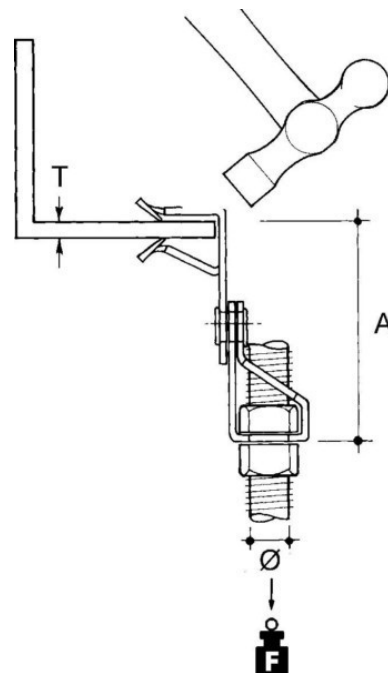

[Fixing clamp Clamp Thread 10 AH38-AM10T online kaufen](#)