

T-head bolt for channels Steel HM 308/50

Allgemeine Informationen

Products_Model	ET0477583
EAN	4013339122103
Producer	Niadax
Producer-Model	HM 308/50
Producer-Typ	HM 308/50
min. Order	
Class	Hammerkopfschraube

Technische Informationen

Werkstoff	
Oberfläche	
Gewindemaß metrisch	
Länge	50mm
Kopfbreite	20mm
Geeignet für Montageschiene	

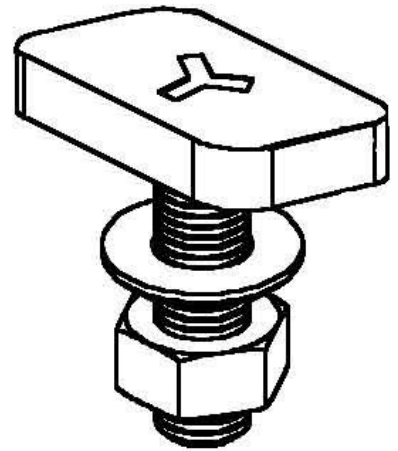

[T-head bolt for channels Steel HM 308/50 online kaufen](#)

