

Mounting plate for cable protection tubes Metal MIMPA 30/260E3

Allgemeine Informationen

Products_Model	ET5404309
EAN	4013339908288
Producer	Niadax
Producer-Model	MIMPA 30/260 E3
Producer-Typ	MIMPA 30/260 E3
min. Order	
Class	Montageplatte für Installationsrohre/Kabelschutzrohre

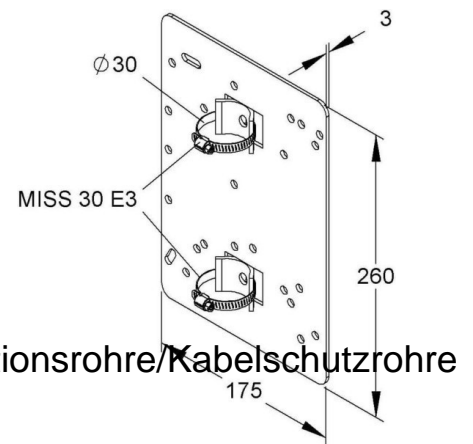

Technische Informationen

Werkstoff	
Oberfläche	
Oberfläche poliert	
Außendurchmesser	30mm
Breite	175mm
Höhe	260mm

[Mounting plate for cable protection tubes Metal MIMPA 30/260E3 online kaufen](#)