

Fixing clamp Clamp Thread 6 NH083-AM6T

Allgemeine Informationen

Products_Model	ET0477627
EAN	4013339756889
Producer	Niadax
Producer-Model	NH083-AM6T
Producer-Typ	NH083-AM6T
min. Order	
Class	Befestigungsklammer

Technische Informationen

Befestigungsart	
Anschlussart/-bauteil	
Gewindemaß metrisch	
Geeignet für Flanschstärke	0.8...3mm
Scharnierend	
Scharnier justierbar	
Werkstoff	
Oberfläche	
Bruchlast	680N

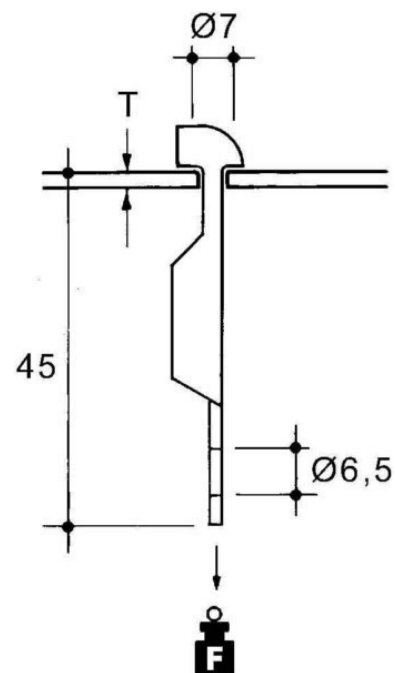

[Fixing clamp Clamp Thread 6 NH083-AM6T online kaufen](#)

