

## Holder for protective hose Plastic Polyamide 28.5 mm 5030025021

### Allgemeine Informationen

Products_Model	ET0538671
EAN	4025113199782
Producer	Flexa
Producer-Model	15030025021
Producer-Typ	RQH AD28,5gr
min. Order	
Class	Halter für Schutzschläuche

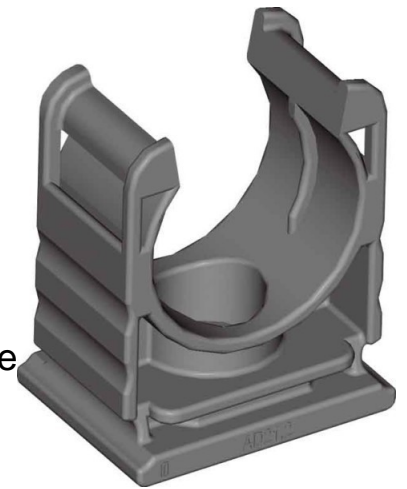

### Technische Informationen

Werkstoff	
Werkstoffgüte	
Nenndurchmesser	28.5mm
Farbe	
Befestigungsart	

[Holder for protective hose Plastic Polyamide 28.5 mm 5030025021 online kaufen](#)

