

Accessories for position switches 69664

Allgemeine Informationen

Products_Model	ET0717832
EAN	4047101248449
Producer	Turck
Producer-Model	69664
Producer-Typ	SKN/M30
min. Order	
Class	Zubehör für Positionsschalter

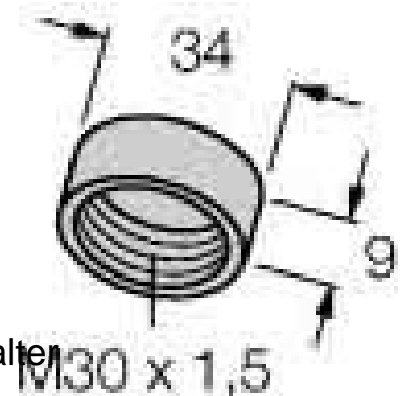

Technische Informationen

[Accessories for position switches 69664 online kaufen](#)

