

T-head bolt for channels Steel Hot dip galvanized HK 512/30 F

Allgemeine Informationen

Products_Model	ET0475242
EAN	4013339124251
Producer	Niedax
Producer-Model	HK 512/30 F
Producer-Typ	HK 512/30 F
min. Order	
Class	Hammerkopfschraube

Technische Informationen

Werkstoff	
Oberfläche	
Gewindemaß metrisch	
Länge	30mm
Kopfbreite	32.5mm
Geeignet für Montageschiene	

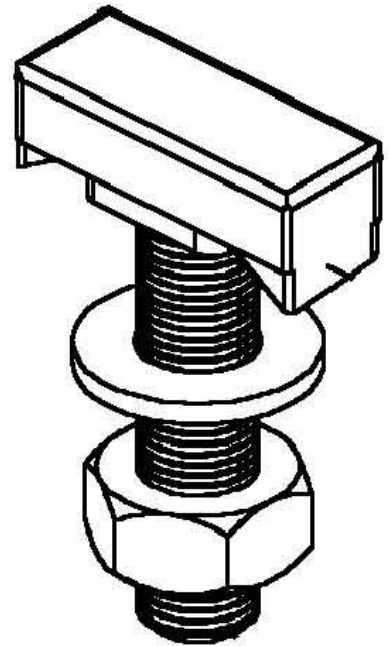

[T-head bolt for channels Steel Hot dip galvanized HK 512/30 F online kaufen](#)

