

Holder for protective hose Plastic 12 mm PA D S G-12

Allgemeine Informationen

Products_Model	ET0505033
EAN	
Producer	Reiku
Producer-Model	PADSG-12
Producer-Typ	PA D S G-12
min. Order	
Class	Halter für Schutzschläuche

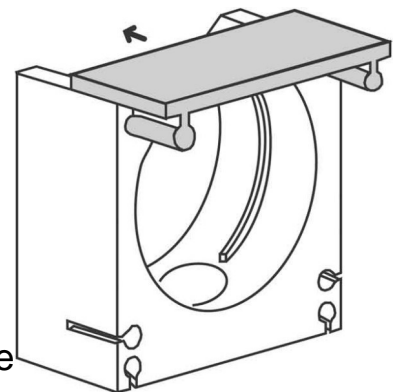

Technische Informationen

Werkstoff	
Nenndurchmesser	12mm
Farbe	
Befestigungsart	

[Holder for protective hose Plastic 12 mm PA D S G-12 online kaufen](#)