

## Mounting plate for distribution board 800 mm 600 mm NSYMR86

### Allgemeine Informationen

Products_Model	ET6004560
EAN	3606480183768
Producer	Schneider Electric
Producer-Model	NSYMR86
Producer-Typ	NSYMR86
min. Order	
Class	Montageplatte für Verteilergehäuse

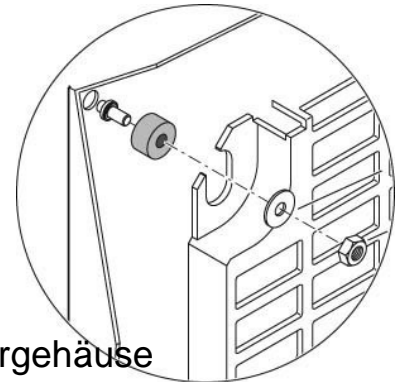

### Technische Informationen

Höhe	800mm
Breite	600mm
Werkstoff	
Oberfläche	
Lochung	

[Mounting plate for distribution board 800 mm 600 mm NSYMR86 online kaufen](#)