

## Mounting plate for distribution board 800 mm 1000 mm NSYMR810

### Allgemeine Informationen

Products_Model	ET6004559
EAN	3606480183751
Producer	Schneider Electric
Producer-Model	NSYMR810
Producer-Typ	NSYMR810
min. Order	
Class	Montageplatte für Verteilergehäuse

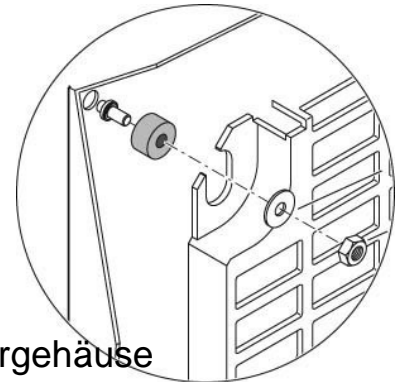

### Technische Informationen

Höhe	800mm
Breite	1000mm
Werkstoff	
Oberfläche	
Lochung	

[Mounting plate for distribution board 800 mm 1000 mm NSYMR810 online kaufen](#)