

Mounting plate for distribution board 600 mm 800 mm NSYMR68

Allgemeine Informationen

Products_Model	ET6004557
EAN	3606480183737
Producer	Schneider Electric
Producer-Model	NSYMR68
Producer-Typ	NSYMR68
min. Order	
Class	Montageplatte für Verteilergehäuse

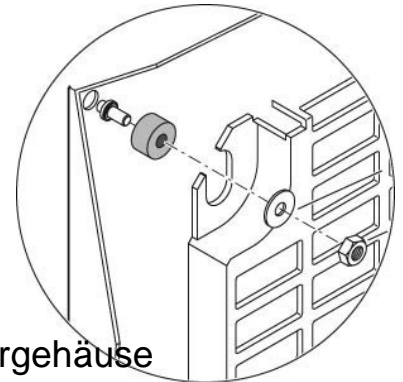

Technische Informationen

Höhe	600mm
Breite	800mm
Werkstoff	
Oberfläche	
Lochung	

[Mounting plate for distribution board 600 mm 800 mm NSYMR68 online kaufen](#)

