

Mounting plate for distribution board 600 mm 400 mm NSYMR64

Allgemeine Informationen

Products_Model	ET6004555
EAN	3606480183706
Producer	Schneider Electric
Producer-Model	NSYMR64
Producer-Typ	NSYMR64
min. Order	
Class	Montageplatte für Verteilergehäuse

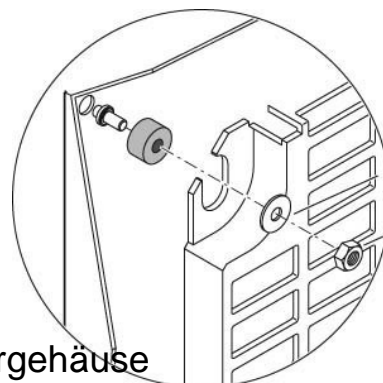

Technische Informationen

Höhe	600mm
Breite	400mm
Werkstoff	
Oberfläche	
Lochung	

[Mounting plate for distribution board 600 mm 400 mm NSYMR64 online kaufen](#)