

Mounting plate for distribution board 300 mm 200 mm NSYMR32

Allgemeine Informationen

Products_Model	ET6004549
EAN	3606480183614
Producer	Schneider Electric
Producer-Model	NSYMR32
Producer-Typ	NSYMR32
min. Order	
Class	Montageplatte für Verteilergehäuse

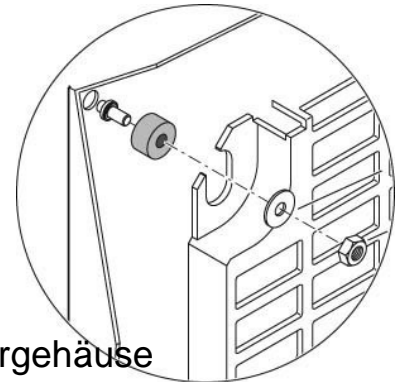

Technische Informationen

Höhe	300mm
Breite	200mm
Werkstoff	
Oberfläche	
Lochung	

[Mounting plate for distribution board 300 mm 200 mm NSYMR32 online kaufen](#)

