

Mounting plate for distribution board 500 mm 300 mm NSYMR53

Allgemeine Informationen

Products_Model	ET6004552
EAN	3606480183676
Producer	Schneider Electric
Producer-Model	NSYMR53
Producer-Typ	NSYMR53
min. Order	
Class	Montageplatte für Verteilergehäuse

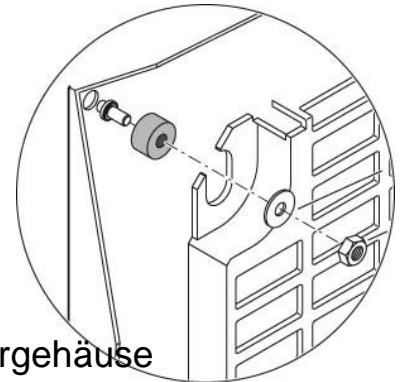

Technische Informationen

Höhe	500mm
Breite	300mm
Werkstoff	
Oberfläche	
Lochung	

[Mounting plate for distribution board 500 mm 300 mm NSYMR53 online kaufen](#)

