

## Mounting plate for distribution board 1200 mm 800 mm NSYMR128

### Allgemeine Informationen

Products_Model	ET6004548
EAN	3606480183591
Producer	Schneider Electric
Producer-Model	NSYMR128
Producer-Typ	NSYMR128
min. Order	
Class	Montageplatte für Verteilergehäuse

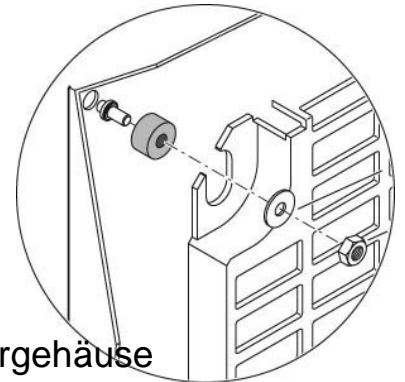

### Technische Informationen

Höhe	1200mm
Breite	800mm
Werkstoff	
Oberfläche	
Lochung	

[Mounting plate for distribution board 1200 mm 800 mm NSYMR128 online kaufen](#)

