

## Mounting plate for distribution board 700 mm 500 mm NSYMR75

### Allgemeine Informationen

Products_Model	ET6004558
EAN	3606480183744
Producer	Schneider Electric
Producer-Model	NSYMR75
Producer-Typ	NSYMR75
min. Order	
Class	Montageplatte für Verteilergehäuse

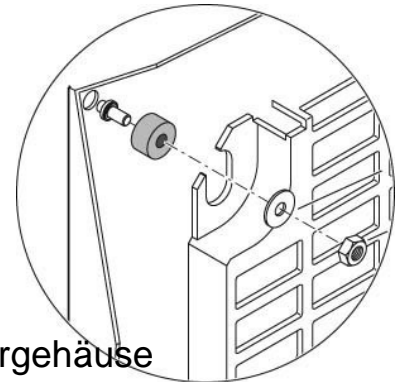

### Technische Informationen

Höhe	700mm
Breite	500mm
Werkstoff	
Oberfläche	
Lochung	

[Mounting plate for distribution board 700 mm 500 mm NSYMR75 online kaufen](#)

