

## Inner corner for installation duct 32 mm 30 mm FI3030.1

### Allgemeine Informationen

Products_Model	ET0402415
EAN	4011126060485
Producer	Kleinhuis
Producer-Model	FI3030.1
Producer-Typ	FI3030.1
min. Order	
Class	Inneneck für Leitungsführungskanal

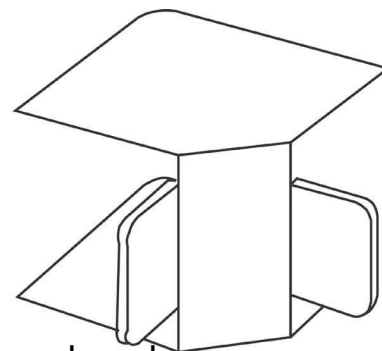

### Technische Informationen

Höhe	32mm
Breite	30mm
Ausführung	
Winkel	90...90°
Werkstoff	
Halogenfrei	
Oberfläche	
Farbe	
RAL-Nummer	
Schutzfolie	
Befestigungsart	

[Inner corner for installation duct 32 mm 30 mm FI3030.1 online kaufen](#)

