

Inner corner for installation duct 9.5 mm 21.5 mm FI1022.1

Allgemeine Informationen

Products_Model	ET0402400
EAN	4011126059908
Producer	Kleinhuis
Producer-Model	FI1022.1
Producer-Typ	FI1022.1
min. Order	
Class	Inneneck für Leitungsführungskanal

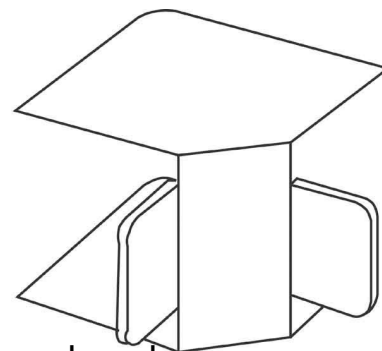

Technische Informationen

Höhe	9.5mm
Breite	21.5mm
Ausführung	
Winkel	90...90°
Werkstoff	
Halogenfrei	
Oberfläche	
Farbe	
RAL-Nummer	
Schutzfolie	
Befestigungsart	

[Inner corner for installation duct 9.5 mm 21.5 mm FI1022.1 online kaufen](#)