

T-head bolt for channels Steel HK 510/50

Allgemeine Informationen

Products_Model	ET0422034
EAN	4013339124008
Producer	Niedax
Producer-Model	HK 510/50
Producer-Typ	HK 510/50
min. Order	
Class	Hammerkopfschraube

Technische Informationen

Werkstoff	
Oberfläche	
Gewindemaß metrisch	
Länge	50mm
Kopfbreite	33mm
Geeignet für Montageschiene	

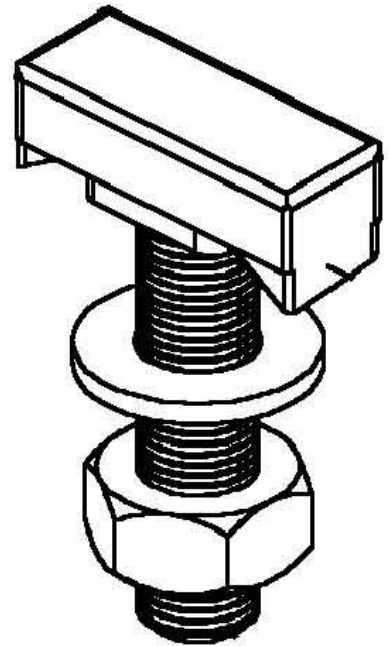

[T-head bolt for channels Steel HK 510/50 online kaufen](#)

