

Mounting plate for distribution board 600 mm 600 mm NSYMR66

Allgemeine Informationen

Products_Model	ET6004556
EAN	3606480183720
Producer	Schneider Electric
Producer-Model	NSYMR66
Producer-Typ	NSYMR66
min. Order	
Class	Montageplatte für Verteilergehäuse

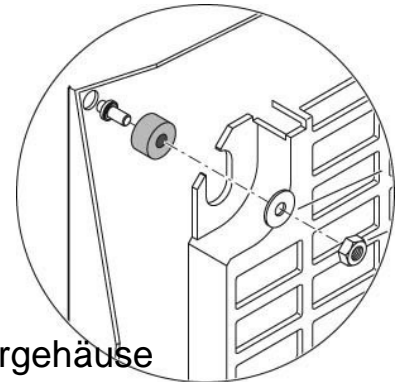

Technische Informationen

Höhe	600mm
Breite	600mm
Werkstoff	
Oberfläche	
Lochung	

[Mounting plate for distribution board 600 mm 600 mm NSYMR66 online kaufen](#)

