

## Mounting plate for distribution board 500 mm 500 mm NSYMR55

### Allgemeine Informationen

Products_Model	ET6004554
EAN	3606480183690
Producer	Schneider Electric
Producer-Model	NSYMR55
Producer-Typ	NSYMR55
min. Order	
Class	Montageplatte für Verteilergehäuse

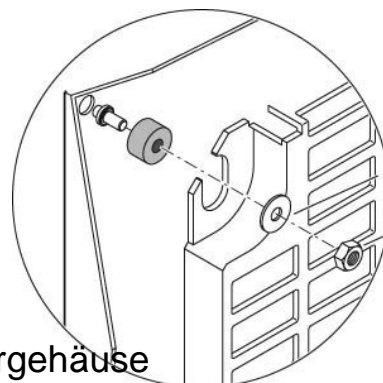

### Technische Informationen

Höhe	500mm
Breite	500mm
Werkstoff	
Oberfläche	
Lochung	

[Mounting plate for distribution board 500 mm 500 mm NSYMR55 online kaufen](#)