

## Bracket for cable support system 230 mm 145 mm KTTS 200

### Allgemeine Informationen

Products_Model	ET5400667
EAN	4013339182800
Producer	Niadax
Producer-Model	KTTS 200
Producer-Typ	KTTS 200
min. Order	
Class	Ausleger für Kabeltragsystem

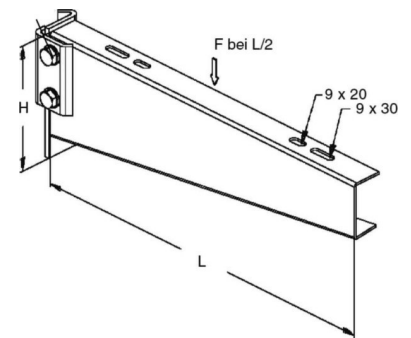

### Technische Informationen

Länge	230mm
Höhe	145mm
Ausführung	
Winkel	90...90°
Geeignet für Funktionserhalt	
Werkstoff	
Rostfreier Stahl, gebeizt	
Werkstoffgüte	
Oberfläche	
Farbe	

[Bracket for cable support system 230 mm 145 mm KTTS 200 online kaufen](#)