

## T-head bolt for channels Steel HM 308/30

### Allgemeine Informationen

Products_Model	ET0469479
EAN	4013339121908
Producer	Niadax
Producer-Model	HM 308/30
Producer-Typ	HM 308/30
min. Order	
Class	Hammerkopfschraube

### Technische Informationen

Werkstoff	
Oberfläche	
Gewindemaß metrisch	
Länge	30mm
Kopfbreite	20mm
Geeignet für Montageschiene	

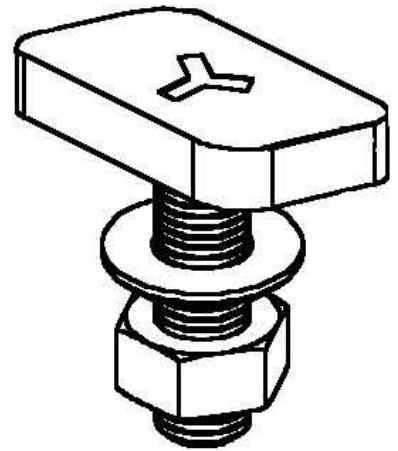

[T-head bolt for channels Steel HM 308/30 online kaufen](#)

