

## Fixing clamp Clamp Conduit/cable AH38-GM1219

### Allgemeine Informationen

Products_Model	ET0412105
EAN	4013339748921
Producer	Niadax
Producer-Model	AH38-GM1219
Producer-Typ	AH38-GM1219
min. Order	
Class	Befestigungsklammer

### Technische Informationen

Befestigungsart	
Anschlussart/-bauteil	
Geeignet für Flanschstärke	3...8mm
Rohr-/Kabeldurchmesser	12...19mm
Scharnierend	
Scharnier justierbar	
Werkstoff	
Oberfläche	

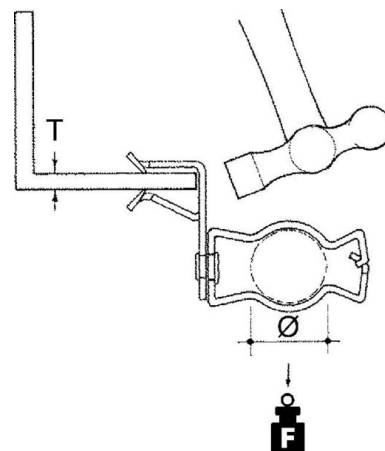

[Fixing clamp Clamp Conduit/cable AH38-GM1219 online kaufen](#)