

Add-on tee for installation duct 40 mm 90 mm Plastic Z4090.1

Allgemeine Informationen

Products_Model	ET0403553
EAN	4011126047721
Producer	Kleinhuis
Producer-Model	Z4090.1
Producer-Typ	Z4090.1
min. Order	
Class	Anbau-Abzweigstück für Leitungsführungskanal

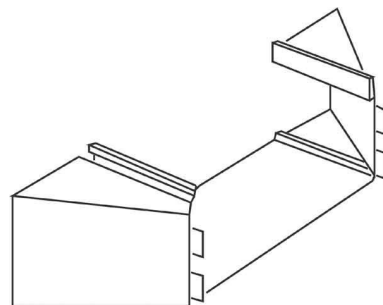

Technische Informationen

Kanalhöhe	40mm
Kanalbreite	90mm
Werkstoff	
Halogenfrei	
Oberfläche	
Farbe	
RAL-Nummer	
Schutzfolie	

[Add-on tee for installation duct 40 mm 90 mm Plastic Z4090.1 online kaufen](#)

