

T-head bolt for channels Steel HM 308/20

Allgemeine Informationen

Products_Model	ET0432400
EAN	4013339121809
Producer	Niadax
Producer-Model	HM 308/20
Producer-Typ	HM 308/20
min. Order	
Class	Hammerkopfschraube

Technische Informationen

Werkstoff	
Oberfläche	
Gewindemaß metrisch	
Länge	20mm
Kopfbreite	20mm
Geeignet für Montageschiene	

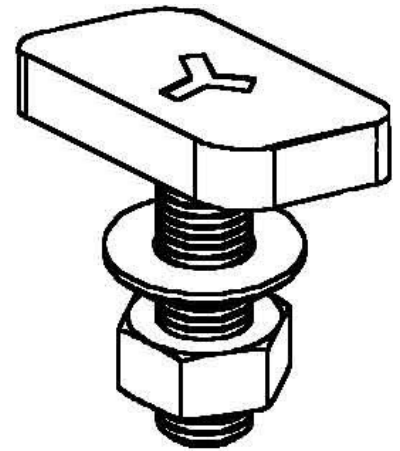

[T-head bolt for channels Steel HM 308/20 online kaufen](#)

