

## Inner corner for installation duct 18 mm 17.5 mm FI2020.3

### Allgemeine Informationen

Products_Model	ET0403587
EAN	4011126343601
Producer	Kleinhuis
Producer-Model	FI2020.3
Producer-Typ	FI2020.3
min. Order	
Class	Inneneck für Leitungsführungskanal

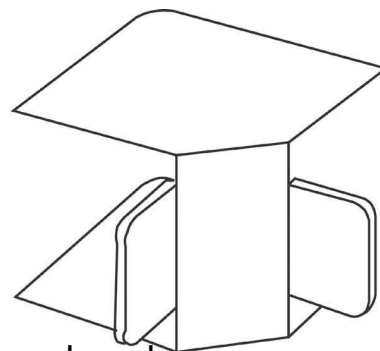

### Technische Informationen

Höhe	18mm
Breite	17.5mm
Ausführung	
Winkel	90...90°
Werkstoff	
Halogenfrei	
Oberfläche	
Farbe	
RAL-Nummer	
Schutzfolie	
Befestigungsart	

[Inner corner for installation duct 18 mm 17.5 mm FI2020.3 online kaufen](#)