

## T-head bolt for channels Steel HK 612/30

### Allgemeine Informationen

Products_Model	ET0412810
EAN	4013339124909
Producer	Niadax
Producer-Model	HK 612/30
Producer-Typ	HK 612/30
min. Order	
Class	Hammerkopfschraube

### Technische Informationen

Werkstoff	
Oberfläche	
Gewindemaß metrisch	
Länge	30mm
Kopfbreite	41mm
Geeignet für Montageschiene	

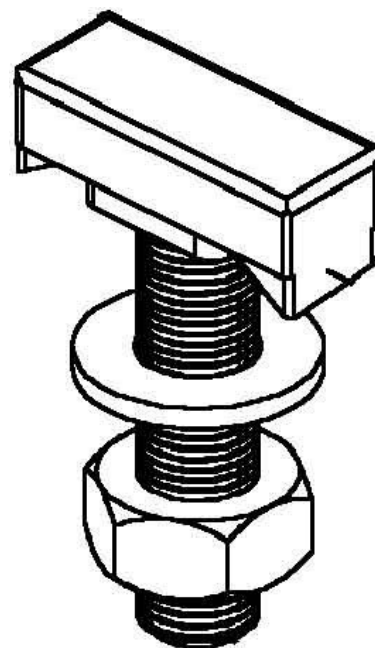

[T-head bolt for channels Steel HK 612/30 online kaufen](#)

