

Fixing clamp Clamp Conduit/cable AH814-GM1219

Allgemeine Informationen

Products_Model	ET0412113
EAN	4013339749041
Producer	Niadax
Producer-Model	AH814-GM1219
Producer-Typ	AH814-GM1219
min. Order	
Class	Befestigungsklammer

Technische Informationen

Befestigungsart	
Anschlussart/-bauteil	
Geeignet für Flanschstärke	8...14mm
Rohr-/Kabeldurchmesser	12...19mm
Scharnierend	
Scharnier justierbar	
Werkstoff	
Oberfläche	

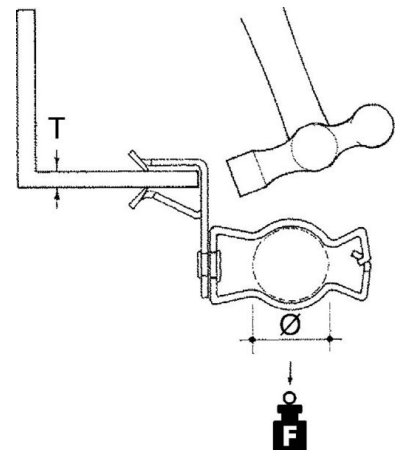

[Fixing clamp Clamp Conduit/cable AH814-GM1219 online kaufen](#)

