

T-head bolt for channels Steel Other HM 410/90

Allgemeine Informationen

Products_Model	ET0477585
EAN	4013339123483
Producer	Niedax
Producer-Model	HM 410/90
Producer-Typ	HM 410/90
min. Order	
Class	Hammerkopfschraube

Technische Informationen

Werkstoff	
Werkstoffgüte	
Oberfläche	
Gewindemaß metrisch	
Länge	90mm
Kopfbreite	31mm
Geeignet für Montageschiene	

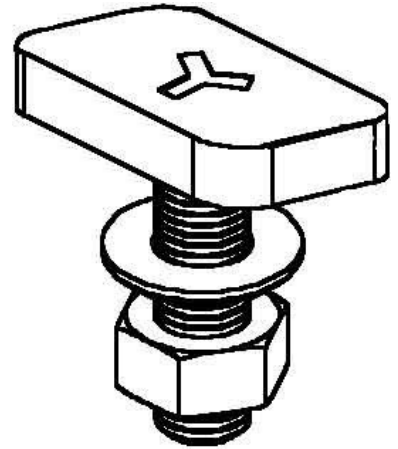

[T-head bolt for channels Steel Other HM 410/90 online kaufen](#)

