

Flat bend for installation duct 80 mm 80 mm LUWC 80.080

Allgemeine Informationen

Products_Model	ET5203586
EAN	4013339791101
Producer	Niedax
Producer-Model	LUWC 80.080
Producer-Typ	LUWC 80.080
min. Order	
Class	Flachwinkel für Leitungsführungskanal

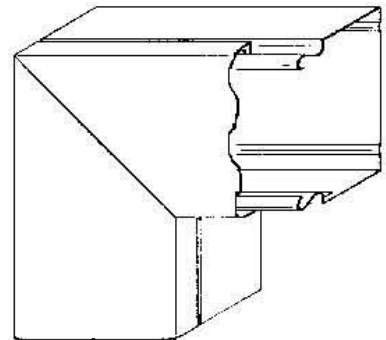

Technische Informationen

Höhe	80mm
Breite	80mm
Ausführung	
Winkel	90...90°
Werkstoff	
Werkstoffgüte	
Halogenfrei	
Geeignet für Funktionserhalt	
Oberfläche	
Farbe	
Schutzfolie	
Befestigungsart	

[Flat bend for installation duct 80 mm 80 mm LUWC 80.080 online kaufen](#)

