

T-head bolt for channels Steel Other HM 408/30

Allgemeine Informationen

Products_Model	ET0422454
EAN	4013339122905
Producer	Niedax
Producer-Model	HM 408/30
Producer-Typ	HM 408/30
min. Order	
Class	Hammerkopfschraube

Technische Informationen

Werkstoff	
Werkstoffgüte	
Oberfläche	
Gewindemaß metrisch	
Länge	30mm
Kopfbreite	31mm
Geeignet für Montageschiene	

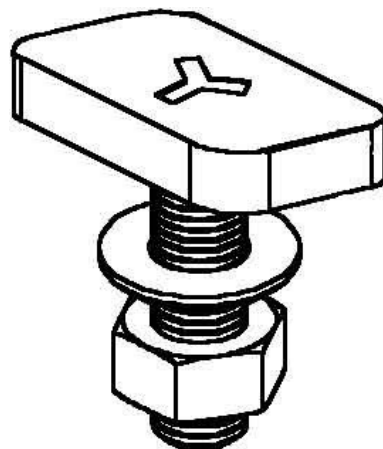

[T-head bolt for channels Steel Other HM 408/30 online kaufen](#)

