

## Bracket for cable support system 540 mm 400 mm 256 mm KTTSS 500

### Allgemeine Informationen

Products_Model	ET5401257
EAN	4013339183647
Producer	Niadax
Producer-Model	KTTSS 500
Producer-Typ	KTTSS 500
min. Order	
Class	Ausleger für Kabeltragsystem

### Technische Informationen

Länge	540mm
Breite	400mm
Höhe	256mm
Ausführung	
Winkel	90...90°
Werkstoff	
Rostfreier Stahl, gebeizt	
Werkstoffgüte	
Oberfläche	
Farbe	

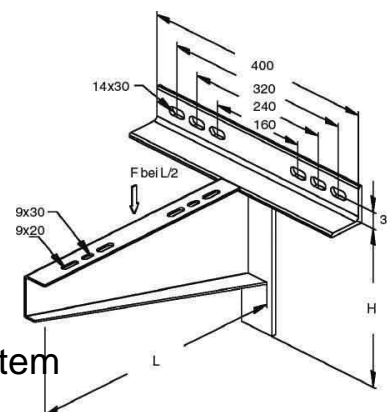

[Bracket for cable support system 540 mm 400 mm 256 mm KTTSS 500 online kaufen](#)