

T-head bolt for channels Steel Other HM 408/50

Allgemeine Informationen

Products_Model	ET0469482
EAN	4013339123100
Producer	Niedax
Producer-Model	HM 408/50
Producer-Typ	HM 408/50
min. Order	
Class	Hammerkopfschraube

Technische Informationen

Werkstoff	
Werkstoffgüte	
Oberfläche	
Gewindemaß metrisch	
Länge	50mm
Kopfbreite	31mm
Geeignet für Montageschiene	

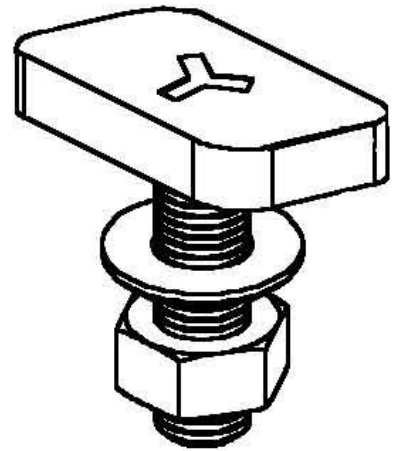

[T-head bolt for channels Steel Other HM 408/50 online kaufen](#)

