

Holder for protective hose Plastic 23 mm PA D S G-23

Allgemeine Informationen

Products_Model	ET0505035
EAN	
Producer	Reiku
Producer-Model	PADSG-23
Producer-Typ	PA D S G-23
min. Order	
Class	Halter für Schutzschläuche

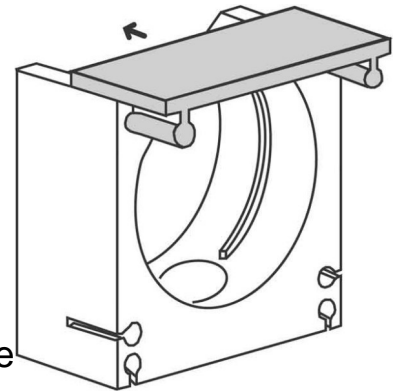

Technische Informationen

Werkstoff	
Nenndurchmesser	23mm
Farbe	
Befestigungsart	

[Holder for protective hose Plastic 23 mm PA D S G-23 online kaufen](#)