

T-head bolt for channels Steel HM 306/20

Allgemeine Informationen

Products_Model	ET0469478
EAN	4013339121502
Producer	Niadax
Producer-Model	HM 306/20
Producer-Typ	HM 306/20
min. Order	
Class	Hammerkopfschraube

Technische Informationen

Werkstoff	
Oberfläche	
Gewindemaß metrisch	
Länge	20mm
Kopfbreite	20mm
Geeignet für Montageschiene	

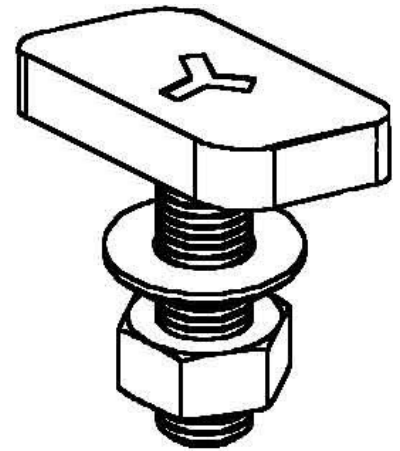

[T-head bolt for channels Steel HM 306/20 online kaufen](#)

