

Mounting material for cable support system Steel MIABR 30 F

Allgemeine Informationen

Products_Model	ET5404259
EAN	4013339907045
Producer	Niadax
Producer-Model	MIABR 30 F
Producer-Typ	MIABR 30 F
min. Order	
Class	Montagematerial für Kabeltragssystem

Technische Informationen

Werkstoff	Rostfreier Stahl, gebeizt
Werkstoffgüte	
Oberfläche	
Farbe	

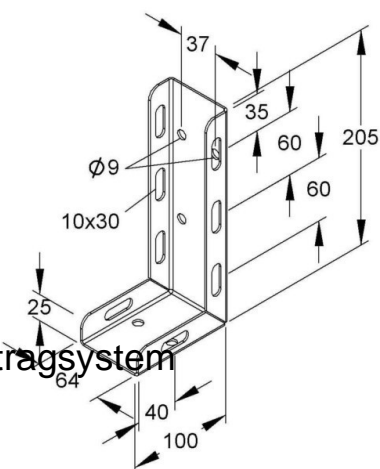

[Mounting material for cable support system Steel MIABR 30 F online kaufen](#)