

## Bracket for cable support system 340 mm 283 mm KTASS 800

### Allgemeine Informationen

Products_Model	ET5401246
EAN	4013339189274
Producer	Niadax
Producer-Model	KTASS 800
Producer-Typ	KTASS 800
min. Order	
Class	Ausleger für Kabeltragsystem

### Technische Informationen

Länge	340mm
Höhe	283mm
Ausführung	
Winkel	90...90°
Werkstoff	
Rostfreier Stahl, gebeizt	
Werkstoffgüte	
Oberfläche	
Farbe	

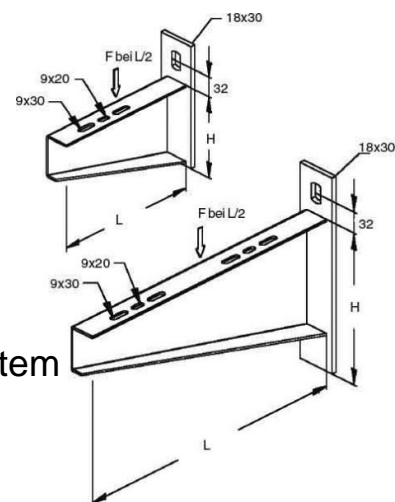

[Bracket for cable support system 340 mm 283 mm KTASS 800 online kaufen](#)