

## Mounting material for cable support system Steel KRWB 60.75 F

### Allgemeine Informationen

Products_Model	ET5404195
EAN	4013339850556
Producer	Niadax
Producer-Model	KRWB 60.75 F
Producer-Typ	KRWB 60.75 F
min. Order	
Class	Montagematerial für Kabeltragsystem

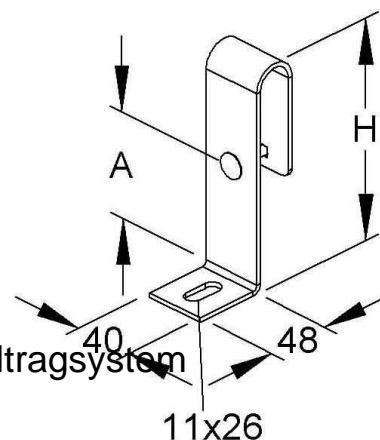

### Technische Informationen

Werkstoff	
Rostfreier Stahl, gebeizt	
Werkstoffgüte	
Oberfläche	
Farbe	

[Mounting material for cable support system Steel KRWB 60.75 F online kaufen](#)