

## T-head bolt for channels Steel Other HM 310/40

### Allgemeine Informationen

Products_Model	ET0431512
EAN	4013339122301
Producer	Niedax
Producer-Model	HM 310/40
Producer-Typ	HM 310/40
min. Order	
Class	Hammerkopfschraube

### Technische Informationen

Werkstoff	
Werkstoffgüte	
Oberfläche	
Gewindemaß metrisch	
Länge	40mm
Kopfbreite	23mm
Geeignet für Montageschiene	

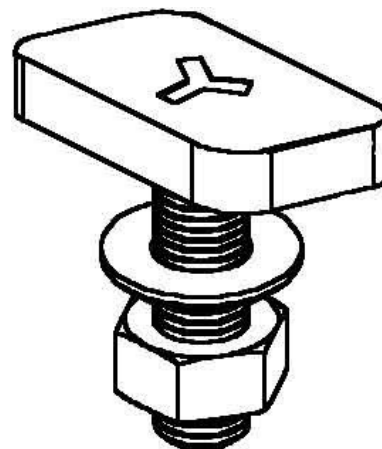

[T-head bolt for channels Steel Other HM 310/40 online kaufen](#)

