

Niedax Hammerkopfschraube HM 308/40

Allgemeine Informationen

Artikelnummer	ET0431499
EAN	4013339122004
Hersteller	Niedax
Hersteller-ArtNr	HM 308/40
Hersteller-Typ	HM 308/40
Verpackungseinheit	100 Stück
Artikelklasse	Hammerkopfschraube

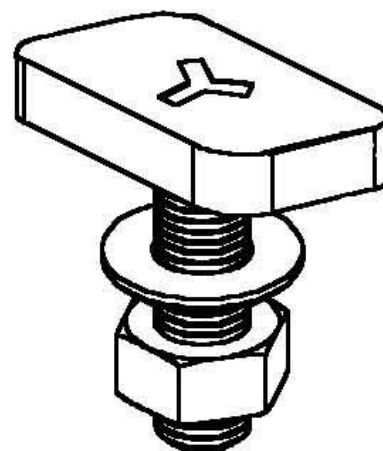

Technische Informationen

Werkstoff	
Oberfläche	
Gewindemaß metrisch	
Länge	40mm
Kopfbreite	20mm

Geeignet für Montageschiene

Niedax Hammerkopfschraube HM 308/40 Werkstoff Stahl, Oberfläche galvanisch/elektrolytisch verzinkt, Gewindemaß metrisch 8, Länge 40mm, Kopfbreite 20mm, Geeignet für Montageschiene, Hammerkopfschrauben an jeder Stelle im Profil einsetzbar, incl.

Mutter u.

U-Scheibe

[Niedax Hammerkopfschraube HM 308/40 online kaufen](#)

